

1

2

3

4

5

6

A

B

C

D

A

B

C

D

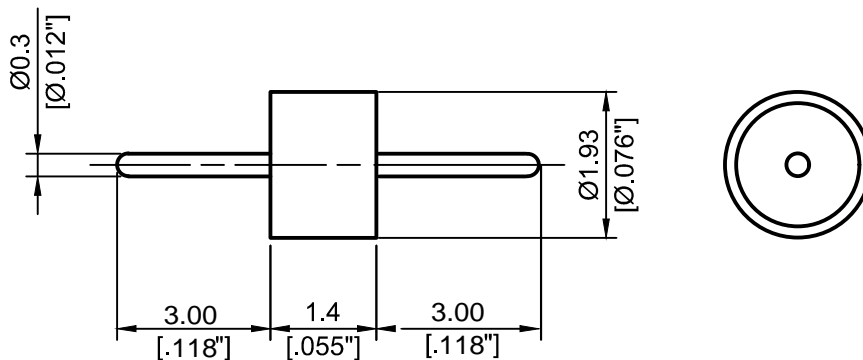

- 1. Pin extensions are $\pm 0.005''$
- 2. Nominal Impedance: 50Ω
- 3. Frequency Range: DC-46GHz
- 4. $R1 \leq 1.1013 \times 10^{-3} \text{ Pa} \cdot \text{cm}^3/\text{s He}$
- 5. Temperature range: $-55 \sim 400^\circ\text{C}$

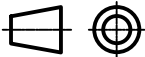
 <p>4th Floor, West Unit, Incubation Building 1 Guanghua Lu, Nanjing TEL: 025-84304950 FAX: 025-84304959 WWW.ALLWINTEK.COM</p>		DIRECTION OF VIEW		UNIT	TITLE
				mm	GLASS BEAD
<small>PROPRIETARY INFORMATION: THE INFORMATION WITHIN THIS DRAWING IS PROPRIETARY AND SHALL NOT BE USED OR DISCLOSED WITHOUT PRIOR WRITTEN PERMISSION FROM ALLWIN TECHNOLOGY.</small>				DRAWN	DWG NO.
				CHECKED	AL-303030
				APPR.	
				<small>UNLESS OTHERWISE SPECIFIED: 1. REMOVE ALL BURRS, BREAK ALL CORNERS, SHARP EDGES 0.05 R MAX 2. LINEARITY TOLERANCES ± 0.2, ANGLE TOLERANCES $\pm 1^\circ$ 3. DIAMETERS ON COMMON CENTERS TO BE CONCENTRIC WITHIN 0.1 4. ALL DIMENSIONS ARE AFTER PLATING, SURFACE FINISHED</small>	
LTR	DESCRIPTION	DATE	APPR.	DO NOT SCALE DRAWING	SIZE A4 a
					SCALE 10:1
					REV. V2.0
					SHEET 1/1

1

2

5

6